

# ANNALES ISLAMOLOGIQUES

**36**

**Extrait**

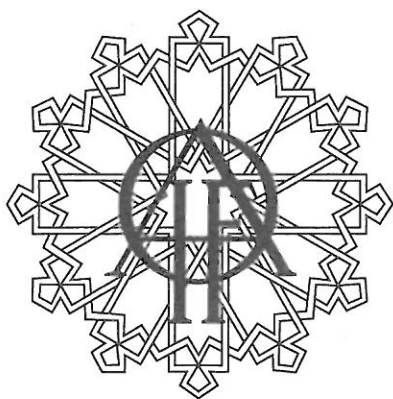

institut français d'archéologie orientale

*AnIsl 36 - 2002*

## The Mosque of Nūr al-Dīn in Mosul 1170 -1172

IN HIS detailed exposition of the meritorious acts of Nūr al-Dīn, the thirteenth-century Damascene historian Abū Shāma wrote: “[Nūr al-Dīn] built congregational mosques in all regions, of which his mosque in Mosul is the ultimate in beauty and excellence. It is especially praiseworthy that he entrusted its construction and the supervision of its expenses to the *shaykh* ‘Umar al-Mallā,<sup>1</sup> may God have mercy on him, who was a pious man. He was told: ‘such person is not suited for the task’. He replied: ‘If I were to assign this job to one of my associates, whether soldier or scribe, I know that he would oppress some of the time; and a mosque cannot be founded on oppression. I suspect that this *shaykh* will not do wrong; but if he does, then it is his sin not mine.”<sup>2</sup>

This short anecdote about the mosque of Nūr al-Dīn in Mosul is quite telling about one of the last and most important foundations of the Syrian sovereign. First, since Mosul was not directly ruled by Nūr al-Dīn, his building a congregational mosque in it represents an unusual act of patronage that requires greater scrutiny.<sup>3</sup> Second, further investigation into the identity of his appointee, reveals that, more than a simple ascetic, ‘Umar al-Mallā was a Sufi of some note and the pole of opposition to the Christians of Mosul, in particular the Christian vizier Fakhr al-Dīn ‘Abd al-Masiḥ.<sup>4</sup> Finally, it seems clear from Nūr al-Dīn’s hands-off approach to the project and from his entrusting it to a “pious person” that some deemed unsuitable, that he was perhaps concerned less with the details of the construction of his mosque and more with its overall message.

<sup>1</sup> N. Elisséeff, *Nūr ad-Dīn un grand prince musulman de Syrie au temps des croisades 511-569/1118-1174*, (Damascus, 1967), I, 109 and II, 661 read ‘Umar’s *nisba* as Al-Mullā, which is a later designation for religious scholars, particularly among Shī‘īs. But Abū Shāma, *Kitāb al-rawḍatayn fī akhbār al-dawlatayn al-nūriyya wa’l-ṣalāhiyya*, ed. M.H. Aḥmad (Cairo, 1956-62), II, 480 clearly calls him Al-Mallā (the filler), because “he used to fill buckets with lime in return for a wage.”

<sup>2</sup> Abū Shāma, *Kitāb al-rawḍatayn*, II, 20-21.

<sup>3</sup> Rulers and other patrons did sometimes build monuments outside their domain of authority, but in most case these acts

of patronage were made in and around sacred shrines and other sites of pilgrimage, including Mecca, Medina, and Jerusalem for the Sunnis and Najaf, Karbala, Qumm and Mashhad for the Shī‘īs. Even there, most foreign patrons of the medieval period built relatively small structures or additions to larger complexes, although that changed in later centuries.

<sup>4</sup> See Abū Shāma, *Kitāb al-rawḍatayn*, II, 480, where the author describes “scholars and jurists, kings and princes visiting [‘Umar] in his retreat.” And (483-484) where he details *shaykh* ‘Umar’s machinations in affecting the banishment of Fakhr al-Dīn to Syria.

This paper is primarily concerned with the message of the mosque Al-Nūrī in Mosul as it pertains to Nūr al-Dīn's dynastic ambitions in upper Mesopotamia, his constant struggle for Sunni Islam, and his undiminished opposition to Christianity, whether Frankish or local. A discussion of the political and religious circumstances surrounding the creation of this mosque will hopefully shed some light on Nūr al-Dīn's unusual act of patronage and perhaps on the ideological intent of the mosque. But this must be coupled with a careful analysis and reconstruction of the original design and epigraphic program of the mosque, a very difficult task since the mosque no longer exists in anything resembling its twelfth-century form (figs. 1 and 2).<sup>5</sup>

### Nūr al-Dīn in Mosul

Before his death in 1146, ʿImād al-Dīn Zankī, father of Nūr al-Dīn and founder of the Zankid dynasties in Syria and upper Mesopotamia, ruled over a vast region, extending from Mosul to Aleppo and from Edessa to the outskirts of Damascus. His domain was split between his two oldest sons: Sayf al-Dīn Ghāzī, the eldest, took Mosul; Nūr al-Dīn Maḥmūd took Aleppo, to which he added Damascus in 1154. Following a joint campaign the two brothers made in 1146 to wrest Edessa from the forces of the second Crusade, Nūr al-Dīn made a special trip to Mosul, where he witnessed Sayf al-Dīn's investiture and acknowledged his suzerainty over the city.

When Sayf al-Dīn unexpectedly died in 1149, Nūr al-Dīn once again went to Mosul, but this time as the elder of the Zankid household and the nominal suzerain of all its territorial possessions. He arranged for the succession of his younger half brother, Quṭb al-Dīn Mawdūd, who, in return, granted him important provinces along the Euphrates and agreed to pronounce his name during the *khuṭba*. Nūr al-Dīn managed to outlive Quṭb al-Dīn, who died in 1170, at which time Nūr al-Dīn went to Mosul for the third time, also to supervise the succession and reaffirm his own suzerainty over the entire Zankid domain.<sup>6</sup>

This third succession was far from straightforward, however, and its various complications are quite telling about Nūr al-Dīn's huge influence in Mosul and, indirectly, about his motivation for building a congregational mosque there. While on his death bed, Quṭb al-Dīn decided to assign as his successor his oldest son ʿImād al-Dīn II, a decision approved by Nūr al-Dīn since ʿImād al-Dīn had in fact grown up in his court in Aleppo and was married to one of his daughters. But Quṭb al-Dīn's vizier, Fakhr al-Dīn ʿAbd al-Masiḥ, a Christian captive, had another son in mind as successor, the younger Sayf al-Dīn Ghāzī II, and he managed to sway the dying prince toward this choice.<sup>7</sup>

<sup>5</sup> Between 1945 and 1950 the old mosque Al-Nūrī was completely destroyed and rebuilt, using both old and new materials, according to a new plan and design. The dome and all the vaulting were completely torn down and replaced by a flat roof and a hemispherical dome, all made of reinforced concrete. And the interior was completely painted in white, turquoise blue, and silver, giving it a totally modern and sterile appearance.

See especially, S. al-Daywajī, "Al-Jāmiʿ al-Nūrī fī al-Mawṣil", *Sumer* 5 (1949): 276-96 for the entire history of this mosque.

<sup>6</sup> N. Elisséeff, *Nūr ad-Dīn*, III, 650-7. See also Y. al-Tabbaa, *The Architectural Patronage of Nūr al-Dīn, (1146-1174)*, unpublished Ph. D. dissertation, New York University, 1982; esp. 23-26 and 143-157.

<sup>7</sup> N. Elisséeff, *Nūr ad-Dīn*, III, 657-661.

Fakhr al-Dīn's intervention, undoubtedly motivated by his desire to curb Nūr al-Dīn's influence in Mosul, greatly angered Nūr al-Dīn and his designated successor. Matters quickly worsened, and in September 1170 Nūr al-Dīn began preparation to take Mosul. In order to dress his conquest with proper legal garb, Nūr al-Dīn sent an emissary, the famous chronicler 'Imād al-Dīn al-Kātib al-Iṣfahānī, to the Abbasid caliph Al-Mustaḍī, asking for the caliph's permission and blessings. The permission, along with a *khil'a* (robe of honor), arrived while Nūr al-Dīn had already begun his campaign, which took him first to Sinjār, an important town about 75 miles due west of Mosul.<sup>8</sup> Having taken Sinjār by siege, Nūr al-Dīn proceeded to Mosul, which he took in the same year after lengthy negotiations with Fakhr al-Dīn.

Pleading his case for an orderly succession within the Zankid household, Fakhr al-Dīn finally convinced Nūr al-Dīn to accept the succession of his candidate, Sayf al-Dīn Ghāzī II, while agreeing that the older son 'Imād al-Dīn would be made governor of the lesser province of Sinjār.<sup>9</sup> But this concession came with several conditions, which interestingly had little to do with the succession and everything to do with containing the influence of the Christians in Mosul. Nūr al-Dīn's attitude toward the Christian vizier and Christians generally can in fact already be predicted in his letter to Sayf al-Dīn II during the siege of Mosul: "My intention is not the city itself, but to preserve the city for you. For I have received letters telling a thousand tales about 'Abd al-Masiḥ's ill treatment of the Muslims. My aim is to remove this Christian from governing Muslims."<sup>10</sup> This anti-Christian attitude is consistent with other acts of Nūr al-Dīn, including his ruthless repression of the rebelling Christians of Edessa (Urfa) in 1146.<sup>11</sup>

The first of Nūr al-Dīn's conditions concerned Fakhr al-Dīn: he was to leave Mosul for Aleppo, to convert to Islam and to change his name from 'Abd al-Masiḥ (slave of the Messiah) to Abdullah (slave of Allah). With Fakhr al-Dīn thus neutralized, Nūr al-Dīn seems to have felt free to impose various repressive economic and legislative measures that were undoubtedly intended to lower the status and limit the authority of the Christians, who were at that time an especially large minority in Mosul.<sup>12</sup> Specifically, he expanded the collection of tributes from various Christian villages and communities, increased the *jizya* tax, and reinstated the rule that Christians should cut their hair short and wear a distinctive belt, *zinnār*.<sup>13</sup>

Finally, Nūr al-Dīn applied with renewed strictness the "Pact of 'Umar" which upheld the safety of existing churches, but prohibited any new construction or restoration and subjected such violations to confiscation.<sup>14</sup> Although Nūr al-Dīn's earlier atrocities against Edessa in

<sup>8</sup> Abū Shāma, *Kitāb al-rawḍatayn*, II, 478; 'Izz al-Dīn b. al-Athīr, *Al-Kāmil fī al-tārīkh*, ed. C.J. Tornberg (Beirut, 1965) (Reprint, with new pagination of the Leiden edition, 1851-1876), XI, 362-363.

<sup>9</sup> Ibn al-Athīr, *Kāmil*, XI, 363-364.

<sup>10</sup> Ibn Shaddad, *Sīra Ṣalāḥ al-Dīn*, 35 complete bibliographical data; Abū Shāma, *Kitāb al-rawḍatayn*, II, 482.

<sup>11</sup> Edessa had fallen to the Crusaders in 1117 and had since become a Crusader county, the easternmost possession of the Crusaders. In 1144 it was conquered and sacked by 'Imād al-Dīn Zankī, who, however, ordered a stop to the massacre

of the local Christian population before its complete annihilation. See J.B. Segal, *Edessa the Blessed City* (Oxford, 1970), 300-313; and N. Elisséeff, *Nūr ad-Dīn*, II, 377-382; 396-401.

<sup>12</sup> J.M. Fiey, *Mossoul chrétienne. Essai sur l'histoire, l'archéologie et l'état actuel des monuments chrétiens de la ville de Mossoul*, (Beirut, 1959), 35-36.

<sup>13</sup> Jews were also obligated to wear a distinctive mark, in the form of a red piece of cloth attached to the shoulder.

<sup>14</sup> For the full translated text of the pact or covenant of 'Umar, see for example, N.A. Stillman, *The Jews of Arab Lands: A History and Source Book* (Philadelphia, 1979), 157-158.

1146 may be partly attributed to his sense of outrage at the alliance struck by the Armenians of the city with the Crusaders,<sup>15</sup> these later acts were more deliberate and systematic in their selective destruction and pillaging of churches and monasteries. Nūr al-Dīn even appointed the noted jurist Sharaf al-Dīn b. Abī 'Aṣrūn as an inspector of the Christian towns of the Jazīra, giving him a free hand to demolish all new structures and confiscate their endowments.<sup>16</sup>

These repressive acts covered a wide swath of the Christian Jazīra, including Mardin, Nisibis (Nuṣaybīn), Mosul, and other places.<sup>17</sup> In 1171, for example, Nūr al-Dīn mandated the conversion of the Monastery of the Virgins (*Dayr al-Abkār*) near Mardin into a mosque for Kurds. Later in the same year, "he ordered the destruction of all new additions in the churches and monasteries of Nuṣaybīn and several other places."<sup>18</sup> In June, 1172 "the Muslims took over the church of St. Thomas in Mardin" and converted it into a mosque, on the pretext that a certain patron of the church named Barṣūm had raped a Muslim woman.<sup>19</sup> Even beyond their immediate negative impact, these anti-Christian measures created an atmosphere of fear among the Christians of Mosul and the Jazīra and contributed to later act of pillage and confiscation.<sup>20</sup> It is undoubtedly because of these repressive measures that Syriac Christian writers, including Michael the Syrian and Bar Hebraeus, were harshly critical of Nūr al-Dīn.<sup>21</sup>

Nūr al-Dīn stayed twenty-four days in Mosul, during which time he ordered the foundation of a congregational mosque in a thinly populated part of the city.<sup>22</sup> Surveying this location from a nearby minaret, he ordered the annexation of adjoining houses and shops, but only after their owners had been adequately compensated.<sup>23</sup> He then appointed *Shaykh* 'Umar al-Mallā as supervisor of the project, entrusting him with the huge sum of 60,000 dinars for the purchase of these properties and the completion of the mosque.

<sup>15</sup> J.B. Segal, *Edessa*, 300-313.

<sup>16</sup> Michael the Syrian, 3, 299 further comments on the corruptibility of Ibn Abī 'Aṣrūn, who extorted bribes from monks and priests in return for not destroying newly-built structures.

<sup>17</sup> N. Elisseff, *Nūr al-Dīn*, II, 661, proposes that Nūr al-Dīn did not demolish nor confiscate the properties of any of the eight churches in Mosul. But this might just be an inference based primarily on Nūr al-Dīn's strict adherence to Islamic law, which prohibits the destruction or confiscation of previously existing structures.

<sup>18</sup> Michael the Syrian, 3, 298-299.

<sup>19</sup> *Ibid.*, 308.

<sup>20</sup> *Ibid.*, 299-300, where the author describes attacks by Kurds against the monastery Mār Mattā near Mosul. In fact, it seems that anti-Christian acts continued after the death of Nūr al-Dīn, for several Christian writers report "a wave of pillaging that lasted three months in 1195, during which the 'great sultan of the Turks' occupied Nisibis and Mosul" (J.M. Fiey, *Mossoul chrétienne*, 37-38).

<sup>21</sup> In fact, Michael the Syrian (3, 300) attributes a letter by Nūr al-Dīn to the caliph of Baghdad that calls for nothing less than the forced conversion or outright slaughter of all Christians in Muslim lands. In this alleged letter Nūr al-Dīn proposes that "the dictum of Muḥammad the Prophet, which is in the Qur'ān, that Muslims should not harass Christians for a period of five hundred years, has expired with the termination of these years.

It follows then that all Christians in regions subject to Muslim control should be killed, unless they should convert to Islam." Interestingly, a similar proposal is attributed to the Fatimid caliph Al-Ḥākim, who when petitioned by Christians in 1013 to refrain from their oppression and destruction of their temples, allegedly declared that the four-century old policy of tolerance had not produced the right results. He then gave the Christians the choice between conversion to Islam and "prompt punishment" for those who refuse. See Yahyā b. Sa'īd al-Antākī, *Tārīkh al-Antākī al-ma'rūf bi-ṣila tārīkh Uṭīkha*, ed. A.U. Tadmurī (Tripoli, 1990), 289-290, 295-299.

<sup>22</sup> The story of Nūr al-Dīn's foundation of this mosque is told in some detail in Abū Shāma, *Kitāb al-rawḍatayn*, I, 20-21; II, 480. See also Sibṭ Ibn al-Jawzī, *Mir'āt al-zamān fi tarīkh al-A'yān* (Heyderabad 1370 AH) VIII, 282. Interestingly, it appears that some coins bearing the name of Nūr al-Dīn were struck in Mosul during or around the time of his presence there. One coin, to my knowledge, has survived: Cairo Museum of Islamic Art, 2/17099, whose verso has the legend Al-Malik al-'Ādil Maḥmūd b. Zankī. It is published in M.B. al-Ḥusaynī, *Al-'umla al-islāmiyya fi al-'ahd al-atābiki*, (Baghdad, 1966), 47.

<sup>23</sup> Some writers, citing "a local Christian tradition," have suggested the existence of a church on the spot where the mosque was built. See F. Sarre, E. Herzfeld, *Archäologische Reise im Euphrat- und Tigris-Gebiet*, (Berlin, 1911-1920), II, 216, where the alleged

The mosque was apparently completed in just under two years, for in 568/1172 Nūr al-Dīn visited Mosul for the fourth and last time and performed the Friday prayer in it. He also formalized the *waqf* allotments of his mosque, which seem to have comprised agricultural lands around Mosul and commercial properties near the mosque, including a large covered market, *qaysāriyya*, with numerous shops.<sup>24</sup> Furthermore, Nūr al-Dīn "gave considerable alms, appointed a *khaṭīb* and muezzins for the mosque, and supplied it with rugs and straw mats".<sup>25</sup> Finally, after the mosque had been completed, Nūr al-Dīn ordered a *madrasa* built next to it and even appointed its first teacher.<sup>26</sup> Nothing has survived of this *madrasa*, but its foundation is perfectly consistent with Nūr al-Dīn's patronage of Sunni institutions all over Syria.

### Archaeology: The Original Mosque

Although the present rebuilt mosque has been stripped of its long history (figs. 1 and 2), Herzfeld's investigation, some early photographs, and the existing architectural and epigraphic remains can help us reconstruct the original mosque and propose a possible chronology for its later phases. Herzfeld's work in the first decade of the twentieth century is the only serious study of this mosque before its demolition and rebuilding in the 1940s. More recent studies by Iraqi scholars, particularly Daywajī and Jum'ā, made minor but important contributions to Herzfeld's work, particularly in terms of the early chronology of the mosque and its ornament and calligraphy. Finally, in 1979 I came upon a wonderful collection of large format glass negatives at the Iraqi Institute for Antiquities, from which I was allowed to make prints of the exterior and interior of the mosque prior to its destruction.

The old photographs show a ruinous and poorly built mosque located at the southern end of a vast enclosure, about 90 × 65 m., approximately corresponding to the present enclosure (fig. 3). The peeling plaster of the southern exterior wall exposed the building material, a conglomerate of rubble and broken bricks, bound with mortar and covered with thick plaster. The sanctuary was choked by parasitical buildings on its south and west, and disfigured by several pierced windows and an unsightly buttress built against the *miḥrāb*. The dome looked misshapen, with a hemispherical lower half incongruously surmounted by a faceted cone (fig. 4). The 60-meter tall minaret (*Al-Hadbā'*) stood, as it still does, at the northwest corner of the enclosure, separated from the sanctuary by an empty court. An exterior *miḥrāb* could be seen about ten meters north of the wall of the sanctuary.<sup>27</sup>

church is called St. Paul. See also N. Elisséeff, "Les monuments de Nūr ad-Dīn", 34; and F.B. Flood, "The Medieval Trophy as an Art Historical Trope: Coptic and Byzantine 'Altars' in Islamic Contexts", *Muqarnas* 18 (2001), 31 n. 78, who cites Elisséeff. But, as Daywajī has previously noted in "Al-Jāmi' al-Nūrī", 286, this legend is not mentioned by any reliable historian, all of whom unanimously speak of an empty lot in the middle of Mosul.

<sup>24</sup> S. al-Daywajī, "Al-Jāmi' al-Nūrī", 279-280 makes an attempt to determine the extent of these *waqf*-s.

<sup>25</sup> Abū Shāma, *Kitāb al-rawḍatayn*, I, 20-21; and Sibṭ b. al-Jawzī,

*Mir'āt al-zamān*, VIII, 282. These chroniclers also report that during this visit, 'Umar al-Mallā offered Nūr al-Dīn, who was sitting by the Tigris river, the account books for the mosque for his verification. Nūr al-Dīn allegedly responded: "da' al-ḥisāb li-yawm al-ḥisāb" (Leave accounting for the Day of Judgement). He then tossed the account books into the river.

<sup>26</sup> Abū Shāma, *Kitāb al-rawḍatayn*, I, 189.

<sup>27</sup> This *miḥrāb*, which dates to the reign of Badr al-Dīn Lu'lu', is now kept in the Mosul Museum, along with several other magnificent stone *miḥrāb*-s.

Even Herzfeld was confounded by the chaotic interior, protesting that the walls were so thickly covered with plaster as to "make the separation of the building phases difficult".<sup>28</sup> Unable to subject the building to a thorough archaeological investigation, Herzfeld instead limited his examinations to the surface (fig. 5). Two types of columns were used in the mosque then, both made of the same soft, dark blue marble common in the area of Mosul since Assyrian times (fig. 6). Type 1 had a thick octagonal shaft with a square frieze and console but no real capital. Type 2 had a thinner composite shaft with four engaged columns and a lyre-shaped capital. The two types were completely different in their height, thickness, shaft, and capitals, and clearly belonged to two different periods. This assertion is confirmed by the fact that several Type 2 columns were placed against the octagonal shaft of Type 1 columns, and a base and an abacus were added to them in order to compensate for the height difference. It is further corroborated by the decoration on the capitals of both column types, which continues behind their point of contact, suggesting originally freestanding columns. From this Herzfeld concluded that the octagonal columns belonged to the first phase while the composite columns belonged to a later phase.

This much is perfectly consistent with archaeological evidence, but what caused Herzfeld to err was that he assumed that the main *mihṛāb* of the mosque was part of the first phase of the building (fig. 7). This *mihṛāb* is dated to Jumada I, 543 / September-October, 1148, which led Herzfeld to conclude that the mosque was first built during the short reign of Sayf al-Dīn Ghāzī I (541/1146-544/1149).<sup>29</sup> Noting further that the capitals of the octagonal columns demonstrated ornamental and paleographic affinities with the *mihṛāb*, Herzfeld, therefore, attributed them all to the first period. Since these columns constituted the main support system of the mosque, Herzfeld went on to conclude that the mosque was not only begun under Ghāzī I, but was actually completed under him.

It followed then that, according to Herzfeld, the building phase of Nūr al-Dīn was a mere restoration, to which he attributed the bundled columns on the basis of their rather superficial similarity to the composite piers at the Great Mosque of Raqqa, which was in fact restored by Nūr al-Dīn in 1168.<sup>30</sup> As for the fact that Ibn al-Athīr clearly stated that this mosque was built by Nūr al-Dīn, Herzfeld argued that the Mosulite historian was only eleven to thirteen years old when Nūr al-Dīn began his "restoration" and that he must have repeated faulty information.<sup>31</sup>

This peculiar objection to one of the most important medieval Islamic historians can be rejected out of hand, as it was in fact by Daywajī as early as 1949. Dismissing Herzfeld's objection to the reliability of Ibn al-Athīr's account, Daywajī proposed that, while always reliable, the historian was especially so for the events that took place during his own childhood, for which he often relied on direct accounts from his father, who was a high

<sup>28</sup> F. Sarre, E. Herzfeld. *Archäologische Reise*, II, 216. Herzfeld also dares the application of this thick plaster to the repairs of the 1860s, which is quite probable since it is unlikely that such a crude restoration would have occurred earlier.

<sup>29</sup> *Archäologische Reise*, II, 216-231. This chronology was accepted by N. Eliséeff, "Les monuments de Nūr ad-Din", *BEO* 13 (1949-

1950), 34; and *idem*. *Nūr al-Dīn*, I, 109, where the author even attributes the minaret 1148. The chronology is also repeated, with some caution, in R. Ettinghausen, O. Grabar, *The Art and Architecture of Islam 650-1250*, date & place, 298.

<sup>30</sup> *Archäologische Reise*, II, 216-219.

<sup>31</sup> *Archäologische Reise*, II, 224.

official at the Zankid court of Mosul. Furthermore, Daywajī added that the details of Nūr al-Dīn's acquisition of the land for the mosque, the specific sum of 60,000 dinars which he endowed for the mosque, and the *waqf*-s for which he allotted were all too specific to be mere fabrication, especially since only 25 years separated Ghāzī's death and the beginning of the mosque.<sup>32</sup> Finally, not one historian either disputed Ibn al-Athīr's account or even proposed an alternative one that mentions Ghāzī I.<sup>33</sup>

Archaeologically, Daywajī pointed out that the *mīhrāb* of 1148 –the cornerstone of Herzfeld's periodization– was not indigenous to the mosque, but had been brought to it from the Umayyad mosque of Mosul by a Shaykh Muḥammad al-Nūrī in 1864, as part of a restoration project.<sup>34</sup> Even a cursory examination of the *mīhrāb* before its most recent restoration is enough to suggest that it was not intended for this mosque but rather brought into it in fragments and reassembled, using no less than a dozen other fragments originating from three or four sources (figs. 7 and 8).<sup>35</sup> Thus, the 1148 *mīhrāb* did not belong to the original mosque of Nūr al-Dīn, although its stunning arabesque ornament is clearly related to the later arabesque decorations on the capitals of the mosque of Nūr al-Dīn and to the even later ornament on the *mīhrāb* that Badr al-Dīn Lu'lu' added to the mosque.<sup>36</sup>

If the octagonal columns, therefore, constitute the support system of the Nūrīd mosque, where did the other columns, with their composite shafts and lyre-shaped capitals, come from? Although Herzfeld is right in tracing the form of their shafts and capitals back to Raqqa and then Samarra, these basic similarities need not argue for an early date, for the Mosul columns show considerable development over their brick and stucco prototype. In addition to being carved out of stone rather than molded in stucco, the Mosul capitals have a greater three-dimensional feel, most clearly visible in the treatment of the corners. Similarly, while the shafts of the Mosul columns can be compared to the brick piers with four engaged columns in Raqqa and Samarra, in Mosul the four engaged columns have

<sup>32</sup> S. al-Daywajī, "Al-Jāmi' al-Nūrī", 280-283.

<sup>33</sup> For example, in the lists of pious foundations, which are normally included in the obituaries of important persons, not one medieval chronicler referred to the foundation of a mosque by Sayf al-Dīn. Ibn al-Athīr, *Al-Kāmil*, XI, 138-139 mentions the large *madrasa* Al-Atābikiyya al-'Atīqa and a *khānqa*, but no mosque. The same information is repeated in Abū Shāma, *Kitāb al-rawḍatayn*, I, 168. Cf. N. Elisséeff, "Les monuments de Nūr ad-Dīn," 34, where he repeats Herzfeld's faulty chronology without citing any Arabic sources in its support.

<sup>34</sup> See S. al-Daywajī, "Al-Jāmi' al-Nūrī", 282-283; and *idem.*, "Al-Jāmi' al-Umawi fi al-Mawṣil", *Sumer* 6 (1950), 216. The removal and reuse of *mīhrāb*-s is not without precedent in Islamic architecture. After all, the so-called Khasseki *mīhrāb*, possibly dating to the second half of the eighth century, was discovered in a mosque founded in 1658. See F. Sarre, E. Herzfeld, *Archäologische Reise*, II, 139-144. In some respects, the *mīhrāb* of Qayrawan, which was first made in 836, but which is popularly attributed the original mosque of Sidi 'Uqba

of 670, belongs to a similar phenomenon of the reuse of ancient *mīhrāb*-s as cult objects. See, for example, K.A.C. Creswell, *A Short Account of Early Muslim Architecture*, revised and supplemented by J.W. Allan (Cairo, 1989), 325.

<sup>35</sup> A longer examination of this *mīhrāb* is beyond the scope of this paper, but it should be noted that its outstanding vegetal ornament and multiple epigraphic styles are potentially quite informative about medieval stone carving in Mosul. All the inscription fragments are Qur'ānic, with the exception of a small fragment in the upper left hand corner, which states: "Al-Jāmi' al-Nūrī", most likely referring to a later work of restoration. The epigraphic style looks late, possibly from the fifteenth or sixteenth century. See F. Sarre, E. Herzfeld, *Archäologische Reise*, I, 17-18.

<sup>36</sup> It is even possible that 'Uthmān al-Baghdādī, the artisan of the 1148 *mīhrāb*, may have himself supervised the work on the columns. As for the Badr al-Dīn *mīhrāb*, which is today preserved at the Mosul Museum, see *Archäologische Reise*, II, fig. 235 and III, pl. XCII.



been collapsed into the square shaft, turning the composite pier into a fully rounded bundled column. Such bundled columns are practically unknown in Islamic architecture.<sup>37</sup>

But similar bundled columns with lyre-shaped capitals are fairly common in the Christian buildings of Mosul, including the churches of Mār Aḥūdemmeḥ, Mār Isha'ya, and Mār Jurjīs, where they generally date to the first half of the thirteenth century (fig. 9).<sup>38</sup> It is therefore likely that these columns were salvaged from a ruined or destroyed Christian church and brought into the mosque. Unlike the inscribed capitals from the Nūrid phase, none of the lyre-shaped capitals contain any Arabic, let alone Qur'ānic inscriptions, further setting them apart from the original mosque. Judging from the crude way by which they were juxtaposed against the octagonal columns, I would suggest that they were added to the mosque at a very late date, possibly in the 1860s, when the *mihrāb* was also brought in.

The mosque was then built from start to finish in one endeavor by Nūr al-Dīn, using heavy octagonal columns with inscribed capitals. How these columns were arrayed and what they supported remain problematic since the mosque has been entirely rebuilt according to a new plan and since early photographs show very little of the vaulting, except for the *mihrāb* dome. Fortunately, Herzfeld made a plan and perspective drawing of the mosque as it appeared before its reconstruction and also proposed a restoration plan that purports to show the mosque in its original Nūrid design. The pre-reconstruction mosque was a broad and narrow structure (approximately 75 × 20 meters), seven bays wide and only one and a half bays deep, with a large dome over the *mihrāb* (fig. 10). The seven bays at the *qibla* wall were alternately large squares and smaller rectangles, while those north of them were small rectangular bays, each with a door to the courtyard.

In his restoration plan, Herzfeld seems to have doubled the existing mosque along its north-south axis, creating a very large mosque (75 × 38 m), four bays deep and seven bays wide (fig. 11). These bays alternate in both depth and breadth between wide and narrow, such that there are two wide and two narrow horizontal rows and three wide and four narrow vertical aisles. The bays are covered with a system of alternating domes and barrel vaults, for a total of six large and eight smaller domes. Therefore, rather than a narrow hypostyle mosque that is focused on a *maqṣūra* dome, Herzfeld proposes a deeper mosque with a rhythmic alternation of bays, but without a dominant *maqṣūra* dome.

Even by his own admission, however, Herzfeld's restoration plan is based more on aesthetic prerogatives than on adequate archaeological evidence. In fact, at least two archaeological features—the number of available columns and the *mihrāb* dome—argue against his plan and its peculiar vaulting system. The plan requires about 140 columns, more than four times the number of octagonal columns existing today.<sup>39</sup> In the absence of so many columns, it appears more likely that the Nūrid mosque more-or-less resembled the mosque that Herzfeld saw in 1910 and that is documented in early photographs. Although

<sup>37</sup> Bundled brick piers are known from the Buyid rebuilding of the Masjid-i Jāmi in Isfahan; see R. Hillenbrand, *Islamic Architecture: Form, Function, Meaning*, (New York, 1994), fig. 2.270.

<sup>38</sup> *Archäologische Reise*, II, 293-295 and figs. 280 and 282. Most of these churches seem to have been restored during the

relatively tolerant period of Badr al-Dīn.

<sup>39</sup> Twenty-four original octagonal columns have been used in the modern mosque, while about ten more were made after their model. Restoration reports I briefly read in 1979 indicate that some of the more damaged columns were simply discarded.

it is not unlikely that this mosque had barrel vaults, there is little support for the vaulting system proposed by Herzfeld, particularly the large number of domes. Certainly, none of these proposed domes appear in the old photographs of the mosque's roof, which is flat with the exception of the large *mihrāb* dome (fig. 3).

Herzfeld omitted the dome over the *mihrāb* from the original plan of the mosque Al-Nūrī, noting that its 16-sided pyramidal exterior looked like a later restoration, but failing to take account of its interior appearance because "it lay in such darkness".<sup>40</sup> But there are fairly clear clues, both on the exterior and on the interior, that the pre-restoration dome represented two building phases. Looking at early photographs of this misshapen dome, we note that it first springs from its octagonal drum as a regular hemispherical dome before turning, about a third of the way up, into a faceted cone (figs. 3 and 4). This agglutination is clearer on the interior of the dome, where a zone of pendentives with large *muqarnas* cells provide the transition to the octagon (fig. 12). Twenty-four ribs spring from this octagon but end abruptly at about one-third the distance to the peak, where they seem to vanish under thick layers of plaster. This ribbed dome, which corresponds to the exterior hemispherical dome, represents the first building phase, whereas the superimposed 16-sided cone represents a later restoration, possibly from the reign of Badr al-Dīn Lu'lu', who built at least two other double-shell pyramidal domes in Mosul.<sup>41</sup> Further distinguishing the cone from the dome is that its 16 sides do not correspond to the 24 ribs of the first dome.

Ribbed, or gored, domes are indigenous to Mosul and its surroundings, where they are generally datable to the first half of the thirteenth century. One such dome exists at the Mār Behnām monastery just outside Mosul, where it covers the chapel of the Virgin, a chamber datable to the first half of the thirteenth century (fig. 13). This finely constructed dome rests on a sophisticated transition dome and has 16 ribs, but is otherwise closely linked to the dome of the mosque Al-Nūrī. Another dome with 24 ribs has survived at the shrine of Sittna Zainab in Sinjār, where it dates to the period of Badr al-Dīn Lu'lu' (1233-1259).<sup>42</sup> Interestingly, both of these domes have a hemispherical exterior, which may also have been the original shape of the mosque's dome.

It seems likely, therefore, that the mosque of Nūr al-Dīn had a large dome over the *mihrāb*, gored on the inside but perhaps hemispherical on the outside. The shallow plan of the mosque and its *maqṣūra* dome (fig. 14) would seem to link it with a fairly large group of twelfth- and thirteenth-century Syrian and Jazīran mosques that were modeled after the venerable Umayyad mosque of Damascus, including those at Diyarbakir, Mardin, and Dunaysir (Kiziltepe), and possibly also the one at Mayyāfāriqīn (Silvan), which also has similarly alternating bays of varying depths.<sup>43</sup> But the large *maqṣūra* dome was clearly based on the model of Iranian Saljuq domes, particularly the one at the Masjid-i Jāmī in Isfahan, or even the Saljuq dome added to the Great Mosque of Damascus in 1082. Thus,

<sup>40</sup> *Archäologische Reise*, II, 226, and fig. 237.

<sup>41</sup> These are: Imjm Yaḥyā b. al-Qāsim (637/1239-1240) and Imām 'Awn al-Dīn (646/1248).

<sup>42</sup> *Archäologische Reise*, II, fig. 285.

<sup>43</sup> For plans of these mosques, see R. Hillenbrand, *Islamic Architecture*: Harran, 2.40; Raqqa, 2.42; Dunaysir, 2.192; Mayyāfāriqīn, 2.204; Diyarbakir, 2.206. See also T. Sinclair, "Early Artuqid Mosque Architecture", in J. Raby (ed.), *The Art of Syria and the Jazīra, 1100-1250*, (Oxford, 1985), 49-68 for more detailed plans.

despite its use of local materials and vaulting techniques, the mosque Al-Nūrī, presents a synthesis, albeit awkward and incomplete, of the Umayyad mosque of Damascus and of nearly contemporary Saljuq architecture.

### The Inscriptions

Although the mosque is curiously devoid of any historical inscriptions, it is very rich in Qur'anic inscriptions and pious supplications. These exist in three distinct groups: short friezes on the capitals of the octagonal columns; marble bands with black inlaid inscriptions and a fragment of a stucco frieze; and a large panel of stucco decoration above the *mihrab*. The inscriptions on the columns once formed parts of continuous Qur'anic verses, but the recent rebuilding of the mosque seems to have disturbed the original sequence (figs. 15 and 16). Presently twenty-four capitals bear Qur'an 2:255; 9:18-19, and 24:36-38; the marble friezes have most of 2:148-50; and the short stucco frieze contains part of 3:18. Nearly all the capitals of the octagonal columns have vegetal arabesque decoration on three sides, while the north-facing side bears a Qur'anic inscription written on a bed of arabesque. The script used in these inscriptions is a rather squat and fleshy *thuluth*, of a type previously seen in Iranian Saljuq monuments and in some of the buildings of Nūr al-Dīn in Syria.<sup>44</sup> It is also clearly related to, though somewhat more developed than the cursive inscriptions encircling the 1148 *mihrab* in the mosque.

Qur'an 2:255 is the well-known Throne Verse (*āyat al-kursī*), a verse that describes God's omniscience, omnipotence, and dominion over heaven and earth. This is one of the most, if not the most, frequently used verse in monumental inscriptions, where because of its eschatological significance, it is often written at the springing of the dome or within the *mihrab* niche.<sup>45</sup> But it is also often inscribed on portals, *minbar*-s, and tombstones.

For different reasons, Qur'an 9:18 is also extremely common in mosque inscriptions, for, according to Blair, "it is one of only three Koranic references to God's mosques (*masājid Allāh*), a special term distinct from any *masjid* or place of prayer".<sup>46</sup> Its continuation, 9:19, however, is much less common, possibly because it seems to distinguish between passive pious practices – "giving water to pilgrims and the inhabiting of the Holy Mosque" – and active Islamic practices – "struggle in the way of God" – and clearly favors the latter.<sup>47</sup> It was most likely included because it refers to *jihād*, which would link the verse with the *jihād* of Nūr al-Dīn against the Crusaders and possibly even freeing Mosul from the rule of a Christian governor.<sup>48</sup>

<sup>44</sup> A complete catalogue of such inscriptions is hardly necessary. But see, Y. Tabbāa, "The Transformation of Arabic Writing, Part 2, The Public Text", *Ars Orientalis* 24 (1994), figs. 10-15 for comparable examples.

<sup>45</sup> E. Cruishank Dodd, Sh. Khairallah, *The Image of the Word: A Study of Qur'anic Verses in Islamic Architecture*, (Beirut, 1981), and II, 9-17 for a partial list of the occurrence of this verse. Sh.S. Blair, *Islamic Inscriptions*, (New York, 1998), 73-74, 156-157, 195-196.

<sup>46</sup> Sh.S. Blair, *Islamic Inscriptions*, 69.

<sup>47</sup> Translations are from A.J. Arberry, *The Koran Interpreted*, (New York, 1970).

<sup>48</sup> On the *jihād* of Nūr al-Dīn against the Crusaders, see Y. Tabbāa, "Monuments with a Message: Propagation of Jihād under Nūr al-Dīn", in Vl. Goss, Chr. Vezar-Bornstein (ed.), *The Meeting of Two Worlds: Cultural Exchange between East and West during the Period of the Crusades*, (Kalamazoo MI, 1986), 223-240; and C. Hillenbrand, "Jihad Propaganda in Syria from the Time of the First Crusade until the Death of Zengi: The Evidence of

Qur'ān 24:36-37 also makes reference to places of worship: "In temples God has allowed to be raised up, and His Name be commemorated therein; therein glorifying Him, in the morning and the evenings, are men whom neither commerce nor trafficking diverts from the remembrance of God and to perform the prayer, and to pay the alms, fearing a day when hearts and eyes shall be turned about, that God may recompense them for their fairest works and give them increase of His bounty; and God provides whomsoever He will, without reckoning." It was undoubtedly for its evocative linking of the building of "temples" and the "recompense" and "bounty" accruing from this pious act that these verses were commonly placed on mosque portals and *mihrāb*-s. Fragments of the same verses, written in floriated Kufic, flank the 1148 *mihrāb*, originally completely surrounding it, as has been done in the restored *mihrāb* (fig. 8).

In addition to the inscribed capitals, the mosque once contained long friezes with inscriptions, which are now exhibited above the entrance to the Islamic galleries of the Iraqi Museum in Baghdad (fig. 17). These consist of four pieces of white marble (total length 4.35 m) on which the inscription is carved out and filled in with a bituminous paste, an ancient Mesopotamian technique where bitumen is widely available. The use of the same technique in two earlier Nūrid monuments –the *bīmāristān* Al-Nūrī in Damascus (1154) and the mosque Al-Nūrī in Hama (1168)– suggests that the Mosul fragments also belong to the Nūrid phase of the mosque. We can also propose that, as with the inscribed friezes at the Hama mosque, these friezes were once embedded in the *qibla* wall, on both sides of the *mihrāb*.<sup>49</sup>

The fragmentary friezes contain parts of 2:148-150, verses rarely used in inscriptions but that seem quite appropriate in a *qibla* wall. "From whatsoever place thou issueth, turn thy face towards the Holy Mosque; it is the truth from thy Lord. God is not heedless of the things you do. From whatsoever place thou issueth, turn thy face towards it, that the people may not have any argument against you." Originally intended for non-Muslim or early converts to Islam, who were presumably at a loss as to what direction they should turn in their prayer, these verses assert the proper Islamic orientation "towards the Holy Mosque" at Mecca.<sup>50</sup>

Another fragmentary inscription, now lost, has been documented by Herzfeld, who, quite correctly I believe, attributes it to the period of Nūr al-Dīn.<sup>51</sup> The fragment is part of Qur'ān 3:18: "God bears witness that there is no God but He –and the angels, and men possessed of knowledge– upholding justice; there is no God but He, the All-mighty, the All-wise." This verse is nearly as common as the Throne Verse, with which it shares the same concept of God's unity and dominion. Indeed, by using the word *shahada* (to bear witness), which is the root verb for *shahāda* (the Muslim declaration of faith), this verse is an even more assertive statement about the absolute unity of God.<sup>52</sup>

Monumental Inscriptions", in Kh. Athamina, R. Heacock (ed.), *The Frankish Wars and their Influence on Palestine*, (Birzeit, 1994), 60-69.

<sup>49</sup> See Y. Tabbaa, "Monuments with a Message...", 229-231 and fig. 24.

<sup>50</sup> I have generally abstained from over-interpreting Qur'ānic passages since their meaning changes historically and in different contexts. On this issue, see Sh.S. Blair, *Islamic Inscriptions*, 215-217. For this specific interpretation, I have relied on *The Holy Qur'ān: English Translation of the Meanings*

and Commentary, revised and edited by The Presidency of Islamic Researchers (Medina, 1992), 60-61.

<sup>51</sup> *Archäologische Reise*, I, 18. The paleographic style is closely linked to other inscriptions from the second half of the twelfth century.

<sup>52</sup> See Sh.S. Blair, *Islamic Inscriptions*, 198: "With its emphasis on attestation, [3:18] is particularly apt on tombstones, whose inscriptions used the same verb, saying that the deceased attested."

Lastly, the space between the *mihṛāb* and the springing of the dome was previously completely covered with a large panel of molded and carved stucco, which is now partly preserved in the Iraqi Museum in Baghdad (fig. 18). I hope to discuss this complex and interesting panel in a separate article on the patronage of Badr al-Dīn Lu'lu', from whose period the panel most likely dates.<sup>53</sup> But I would like here simply to refer to the central square Kufic inscription, whose text seems to echo similar texts used by Nūr al-Dīn in other mosques. The square Kufic text reads as follows: "Muḥammad, Abū Bakr, 'Uthmān, 'Alī, 'Umar, Ḥasan, Ḥusayn, may God be pleased with them all." This formula—which includes the names of the Prophet, the Companion Caliphs, and the first two Shi'ī imams—is a kind of ecumenical Sunni prayer that was especially common during the period of Nūr al-Dīn. As far as I know, it is first seen in epigraphic form in three mosaic inscriptions at the Umayyad mosque of Damascus, one of which mentions the name of Nūr al-Dīn and the other two are attributable to him. Datable to the year 554/1159, when Nūr al-Dīn carried out important restorations in the Great Mosque, two of these inscriptions are identical in content to the Mosul inscription and one continues to include the name of 'Ā'isha, and Fāṭima.<sup>54</sup>

Although the stucco panel at the mosque most likely dates to the time of Badr al-Dīn, it is quite possible that the square Kufic inscription was modeled after an earlier Nūrīd inscription. The main purpose of these inscriptions was not to gloat over the victory of Sunnis, but rather to present a formula which unites the Sunni sects and which may be found acceptable among the moderate Shi'īs. Badr al-Dīn, who was known for his Shi'ī inclinations, may have found in this formula an acceptable compromise between the two dominant sects in Mosul.<sup>55</sup>

Other than the square Kūfic inscriptions, all the inscriptions in the mosque Al-Nūrī were Qur'ānic, and most of these used rather commonly quoted verses. Two verses, 2:255 and 3:18, present the essence of Islamic theology: God's unity, His omniscience and omnipotence, and His rather anthropomorphic dominion in heaven and on earth. The other three dwell on the mosques (*masājīd*) and temples (*buyūt*) of God and seem to have been specifically chosen for that reason.

But despite their rather commonplace content, the inscriptions are still quite striking by their quantity and accessibility. The large number of inscriptions in the *qibla* wall,

<sup>53</sup> E. Herzfeld (*Archäologische Reise*, II, 226-227) dated this stucco panel to a restoration allegedly carried out by Uzun Hassan in the middle of the fifteenth century. On the basis of comparable stucco work in Iran and in Mosul, that attribution now seems much too late, and a date from the period of Badr al-Dīn Lu'lu' (1233-1259) or even from the original foundation of the mosque in 1170 seems much more likely. The earlier date is quite problematic, however, because it would have to rest completely on comparison with stucco work in eleventh- and twelfth-century Iranian monuments: See, for example, A. Hutt, L. Harrow, *Iran I* (London, 1977), pls. 55-56 (Great Mosque at Ardistan) and pl. 72 (*madrassa* Kuh-i Banan). The

later date seems more likely because other monuments built or restored by Badr al-Dīn contain similarly lavish stucco or even stone work, including the relief panels at the Mār Behnam monastery outside Mosul and the astonishing marble revetments at the shrines of Imām Yaḥyā b. al-Qāsim and Imām 'Awn al-Dīn.

<sup>54</sup> K.A.C. Creswell, *Early Muslim Architecture*, I, 348-349 and figs. 411-412.

<sup>55</sup> Badr al-Dīn Lu'lu' has not received sufficient scholarly attention. See meanwhile, D. Patton, *Badr al-Dīn Lu'lu', Atabeg of Mosul, 1211-1259* (Seattle and London, 1991), esp. 67-69 for a discussion of the ecumenical policy practiced by Badr al-Dīn.

in the *mīhrāb*, and especially on capitals insured that the worshipper would be immersed in the word of God, which he would be able to experience spatially by moving from one capital to the next. The same desire to make inscriptions accessible and legible to the congregation may have been behind the use of the black-inlaid inscriptions, a technique primarily intended to enhance the legibility of religious and historical texts.

### The Minaret

The minaret of the mosque of Nūr al-Dīn is not only the most distinctive feature of the mosque but of Mosul as well. Its tapered cylindrical shaft (45 meters high) springs from a battered cubical base and ends in a little cupola that rises a few meters above a bracketed balcony (figs. 19 and 20). The base and the entire shaft are decorated in typically Iranian brick decoration, both basket weave (*hazār baf*) and strapwork, but without any inscriptions. Three sides of the base are decorated with a simple stepped pattern whereas the western side, which faces an important street, contains an elaborate star pattern. Towering 60 meters over the utterly flat landscape, this is the tallest minaret in Iraq.

The freestanding location of the minaret at the elevated northeastern corner of the courtyard, its extreme height, and its excessive decoration all link it with contemporary Iranian Saljuq minarets, which have been interpreted by Hillenbrand as "expressions alike of conspicuous consumption and conspicuous piety".<sup>56</sup> In other words, these minarets were intended less as a functional appendage of the mosque and more as symbolic features on the urban scale. But whereas Saljuq Iranian minarets—in their excessive number, size, and decoration—may have been intended to address tribal or inter-Islamic differences, the minarets at Mosul and the Jazīra were most likely intended to highlight Islam's dominance over Christianity. That in itself might explain why some of the tallest minarets in the Jazīra—at Mardin, Hasankeyf, Dāqūq, Irbīl, Mosul, and Sinjār—were built in cities with important Christian populations.<sup>57</sup> Furthermore, most were built in the aftermath of the period of tolerance that preceded Nūr al-Dīn and that resulted in the creation of numerous Christian buildings.<sup>58</sup>

<sup>56</sup> R. Hillenbrand, *Islamic Architecture*, 153. See also J. Bloom, *Minaret, Symbol of Islam* (Oxford, 1989), 19, 66, and 73 for the significance of height in minarets.

<sup>57</sup> Although the question of height in minarets has been discussed by Bloom (see n. 55), no one to my knowledge has attempted systematically to link it to the sectarian situation obtaining at the time of the creation of these minarets. But a cursory look at minarets in different parts of the Islamic world seems to suggest such a linkage, though not a congruence. Therefore,

minarets in regions that have historically been devoid of large Christian minorities, such as Yemen, Arabia, and Libya, tend to be short; and minaret built on the "borders" of Islam, such as India, Afghanistan, and Spain, tend to be tall. Elsewhere, the situation varies.

<sup>58</sup> See G. Bell, *The Churches and Monasteries of the Tūr 'Abdīn*, (London, 1982), VII, where M. Mundell Mango refers to: "the fifty-odd churches built and rebuilt in the twelfth century by the bishop of Mardin".

### Conclusion

Nūr al-Dīn founded his mosque in Mosul at the peak of his powers, when his domain extended from Mosul to Cairo and from Diyarbakir to Damascus and when his spiritual aura nearly out-shined that of the Abbasid caliph himself. Far more than an act of restoration to a preexisting mosque, as Herzfeld had proposed, I have argued above that the mosque was entirely built by Nūr al-Dīn, according to a typical Jazīran mosque plan, with a shallow sanctuary and a *maqṣūra* dome, but utilizing unusual octagonal columns with inscribed capitals. I have also discussed the mosque within the context of Nūr al-Dīn's hegemonic ambitions in Mosul and his confrontational relationship with the Christians of Mosul and the Jazīra. Built soon after Nūr al-Dīn had removed the Christian governor of the city and while he was actively engaged in undermining local Christianity and dismantling its structures, the mosque, with its towering minaret, may be seen as a late but definitive statement of Islamic dominion over a city with a substantial Christian population.

But the mosque can also be viewed from a strictly Islamic perspective, though one colored by the traditionalist Sunni beliefs of its founder. I have elsewhere discussed Nūr al-Dīn's pivotal role in enforcing the use of cursive writing for all his public inscriptions, proposing that cursive scripts embodied the exoteric, literalist tenets of the Sunni revival.<sup>59</sup> The Qur'ānic inscriptions at the Mosque Al-Nūrī statement take this exoteric trend a step further, by placing some inscriptions within reading distance of the congregation and by coloristically enhancing the legibility of others. Surrounding the worshipper by evocative Qur'ānic verses, whose impact was audibly reinforced during the Friday sermon, may well have been one of the most successful innovations of this period of heightened piety and increased orthodoxy.<sup>60</sup>

Finally, the mosque Al-Nūrī in Mosul may be seen within the context of Nūr al-Dīn's architectural patronage, which, through its extent, size, and innovation, exerted considerable influence on the architecture of the central Islamic world and created a precedent for later patrons with similar ambitions, including Baybars, Al-Nāṣir Muḥammad, and Tinkiz. Blending established building designs—the hypostyle mosque plan or the *madrassa* courtyard plan with innovative, even showy features (*muqarnas* domes and portals, tall minarets, or inscriptions on capitals)—the architecture of Nūr al-Dīn continues and reinforces an earlier Saljuq trend toward an extraverted Islamic architecture that addresses the spiritual and visual needs of the lay worshipper and user.<sup>61</sup>

<sup>59</sup> "The Public Text", 142-148.

<sup>60</sup> I have previously alluded to Nūr al-Dīn's direct involvement in the nature of sermons given in the various mosques in his domain and how these sermons may have been reinforced by the inscriptions in these mosques. See: Y. Tabbāa, "Monuments with a Message", 229-235; and *idem*, *The Transformation*

*of Islamic Art during the Sunni Revival*, (Seattle and London, 2001), 22-23.

<sup>61</sup> In these respects and others, this trend represents a reversal of Fatimid architectural practice, whose propagandistic message remained encrypted within enigmatic symbols and a nearly indecipherable script.

nain  
itual  
tion  
sque  
low  
bed  
onic  
and  
and  
ruc-  
tent

ored  
in's  
sing  
inic  
ing  
ing  
ose  
the  
60

n's  
ble  
ater  
ciz.  
ard  
or  
lier  
ual

ion,  
ersal  
age  
arly

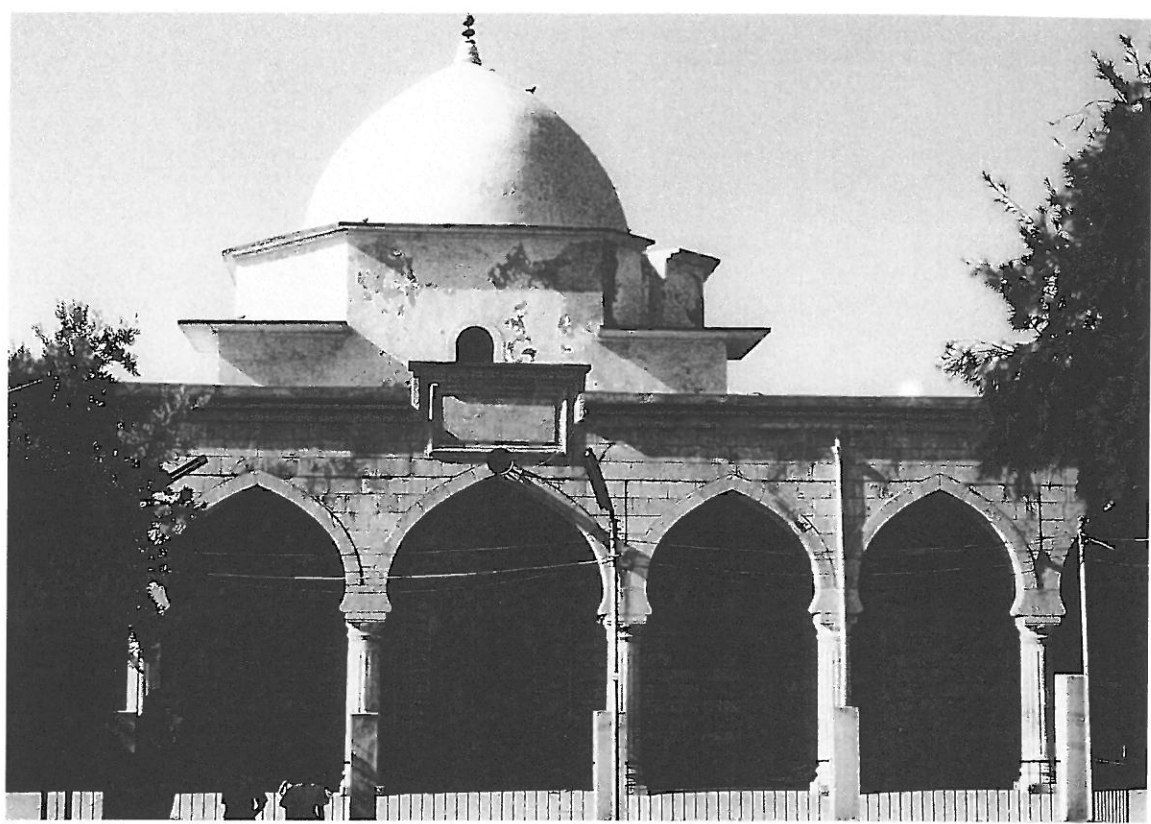

1. Mosul, Mosque Al-Nūri: Dome and portico from courtyard, present condition.

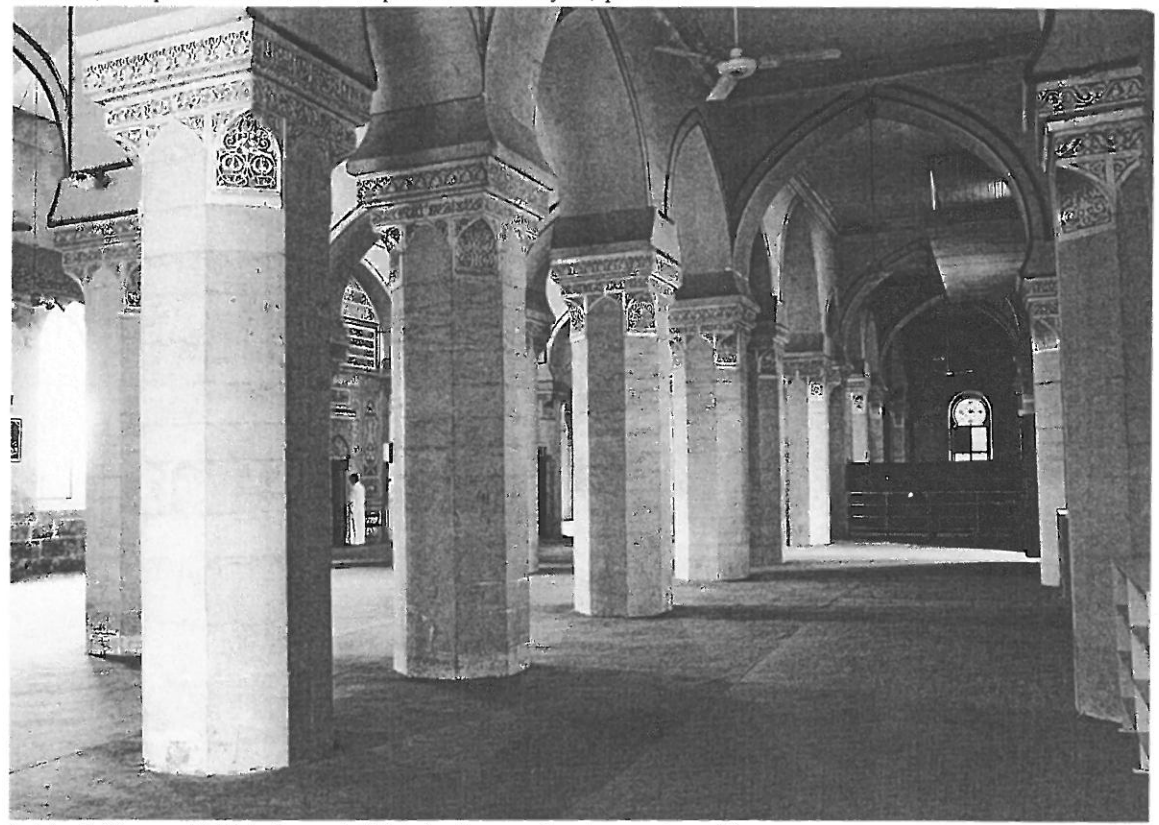

2. Mosul, Mosque Al-Nūri: Prayer hall interior from northeast, present condition.





3. Mosul, Mosque Al-Nūri: Exterior from northwest, condition c. 1930. (Courtesy of the General Institute for Antiquities, Baghdad)



4. Mosul, Mosque Al-Nūri: Exterior from southeast, condition c. 1930. (Courtesy of the General Institute for Antiquities, Baghdad).



5. Mosul, Mosque Al-Nūri: Prayer hall interior from east, condition c. 1930. (Courtesy of the General Institute for Antiquities, Baghdad).

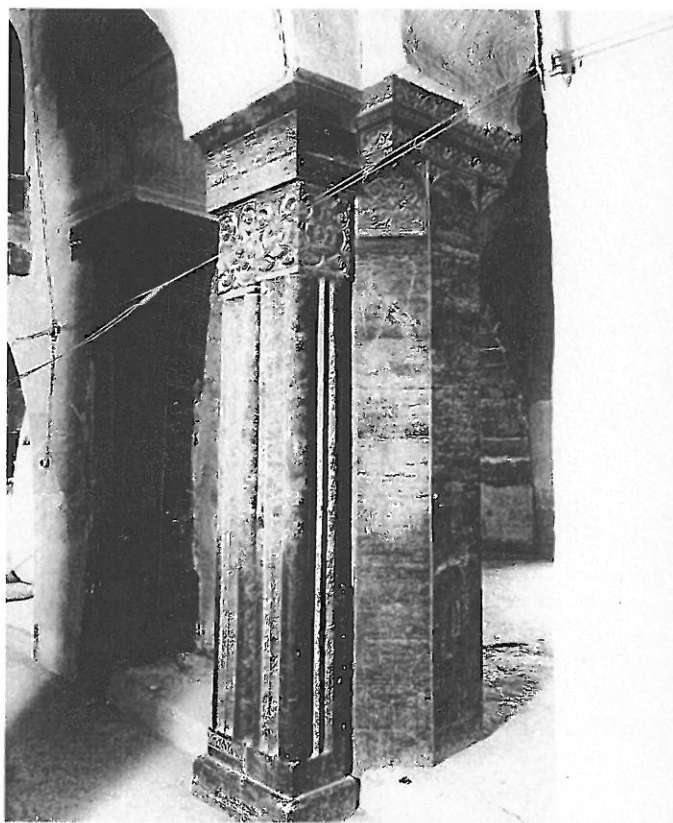

6. Mosul, Mosque Al-Nūri: Type 2 column placed against type 1 column, condition c. 1930. (Courtesy of the General Institute for Antiquities, Baghdad).

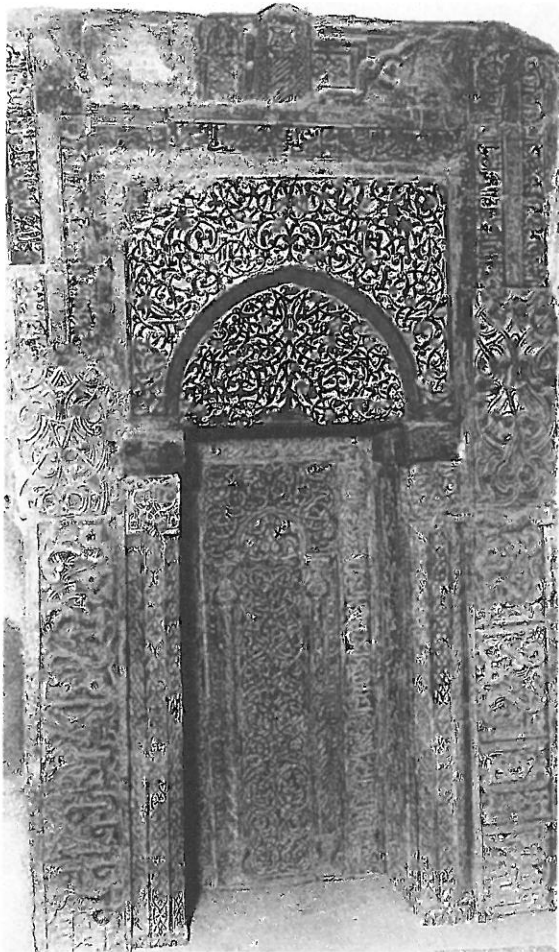

7. Mosul, Mosque Al-Nūri: *Mihrāb*, dated Jumada I, 543/ September-October, 1148, condition c. 1930. (Courtesy of the General Institute for Antiquities, Baghdad).

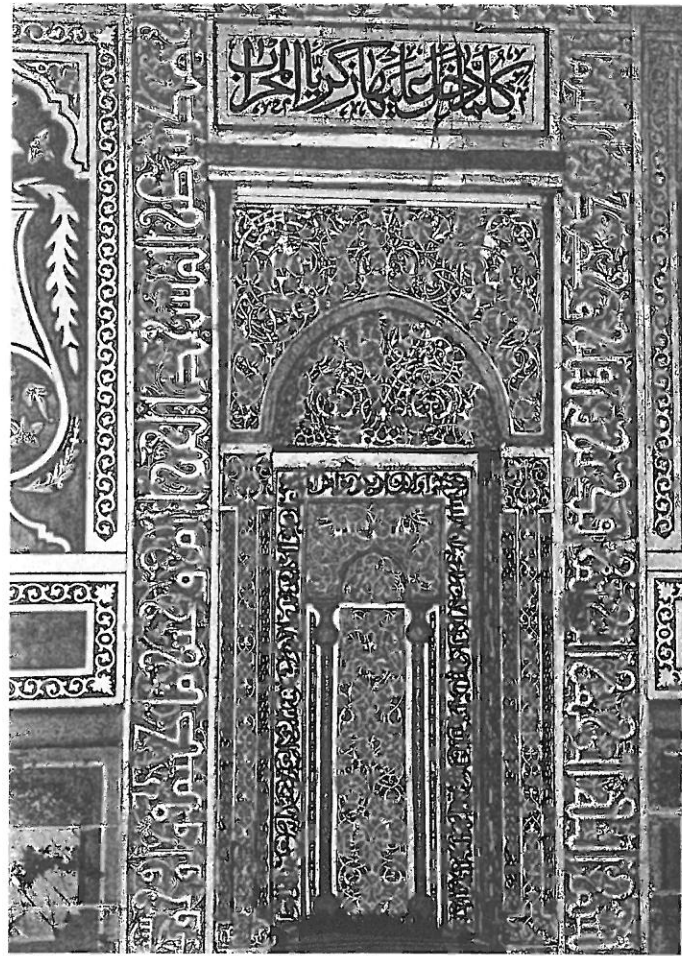

8. Mosul, Mosque Al-Nūri: *Mihrāb*, after restoration.

10.

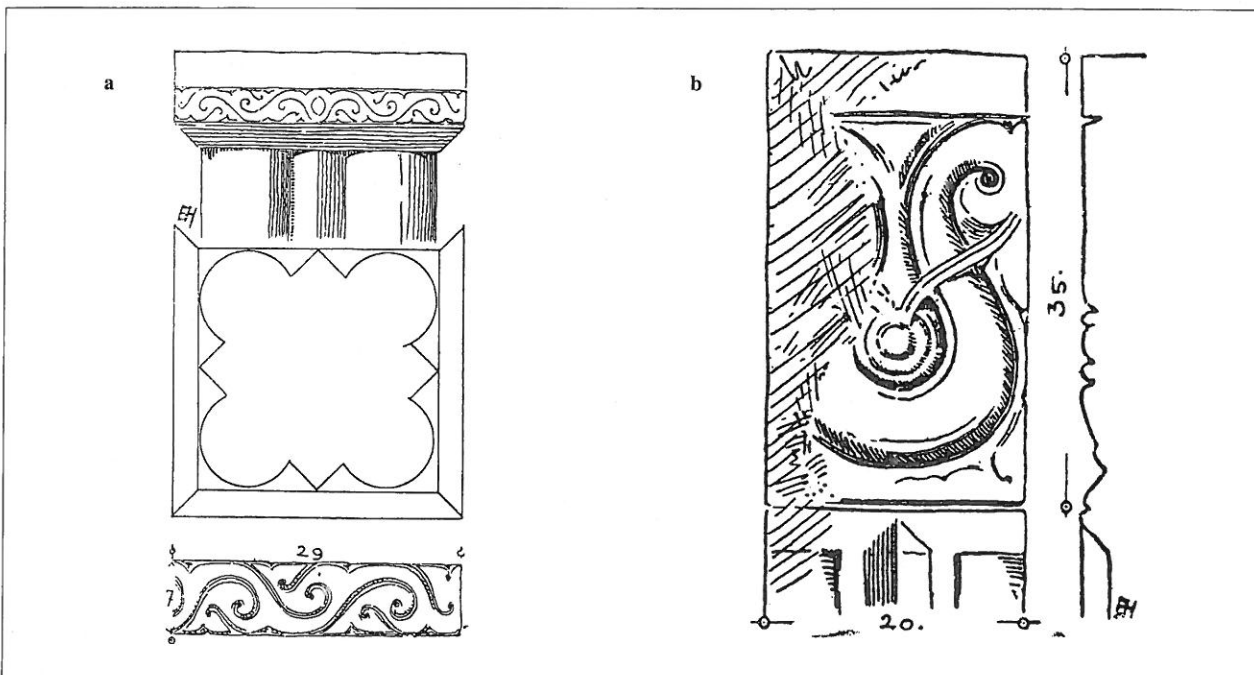

9. Mosul: a. Capital from Mār Jurjīs (*Reise*, 2, fig. 280). – b. Capital from Mār Aḥudemmeḥ (*Reise*, 2, fig. 282).

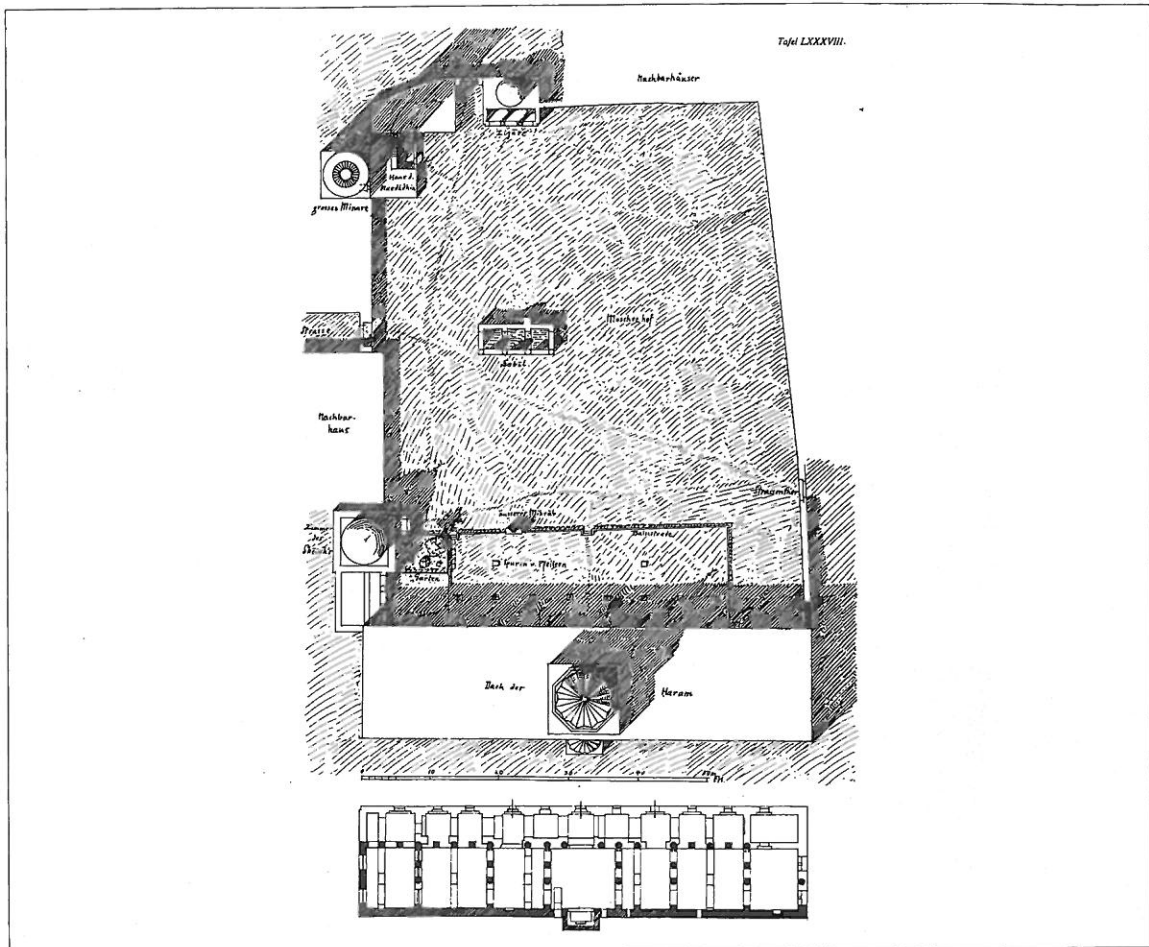

10. Mosul, Mosque Al-Nuri: Plan in c. 1915 (*Reise*, 4, pl. 88).

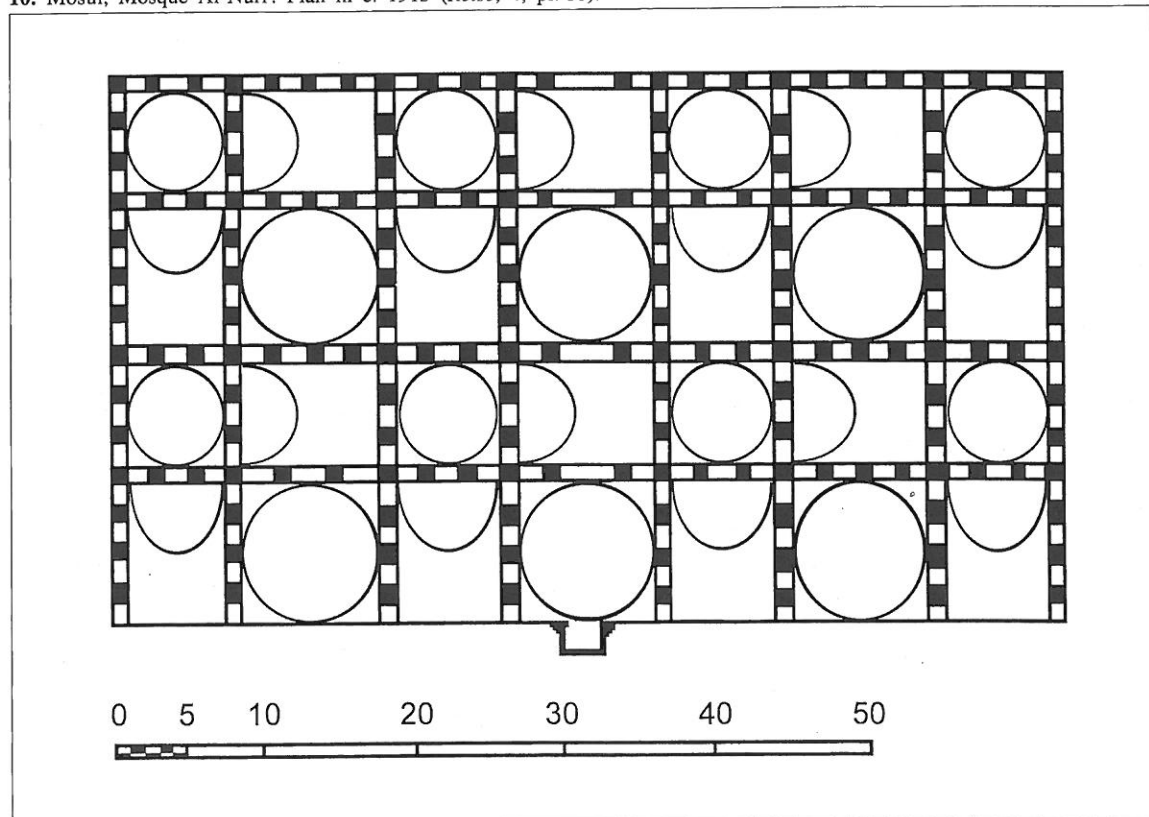

11. Mosul, Mosque Al-Nuri: Reconstruction of plan of first mosque. (Redrawn after Herzfeld in *Reise*, 4, fig. 237).

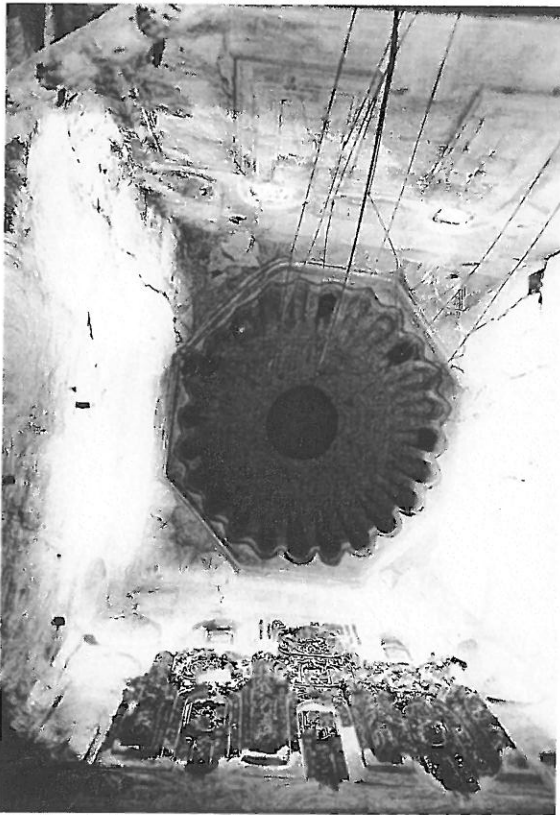

12. Mosul, Mosque Al-Nūri: *Maqṣūra* dome from below. (Courtesy of the General Institute for Antiquities, Baghdad).

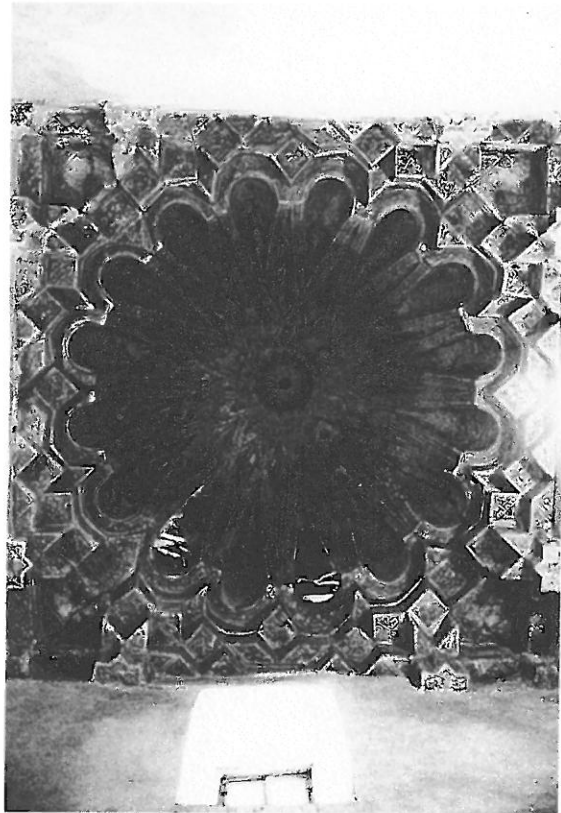

13. Mār Behnām near Mosul: Ribbed vault over the Chapel of the Virgin, first half of the thirteenth century.

15. Mo  
of Qur

16.  
of C

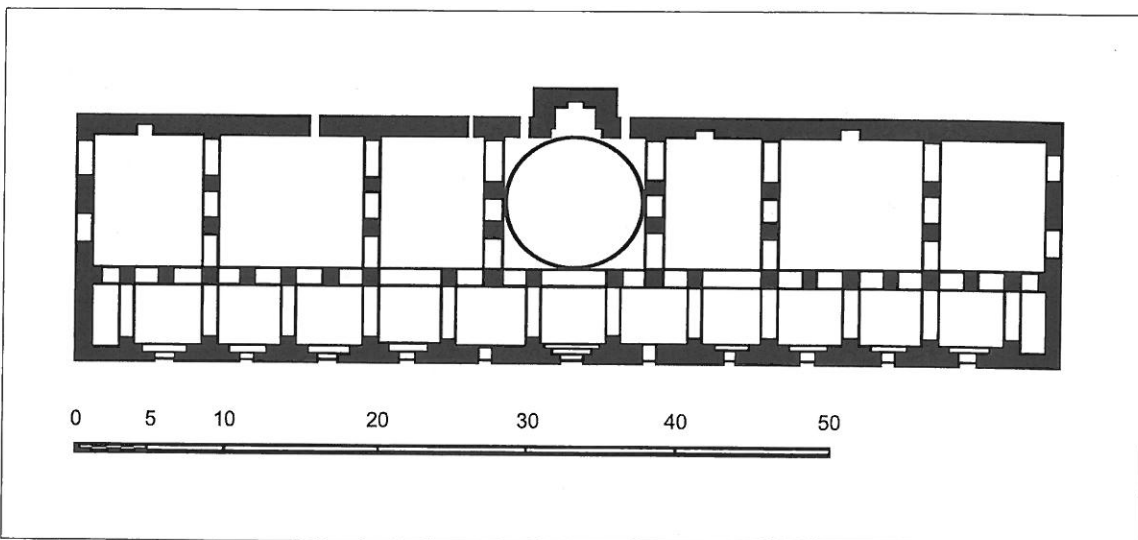

14. Mosul, Mosque Al-Nūri: Reconstruction of plan of first mosque (Adapted with changes from fig. 11).



15. Mosul, Mosque Al-Nūri: a. Capital inscribed with part of Qur'an 2:255.



b. Capital inscribed with part of Qur'an 9:18



16. Mosul, Mosque Al-Nūri: a. Capital inscribed with part of Qur'an 24:36.



b. Capital inscribed with part of Qur'an 24:37.

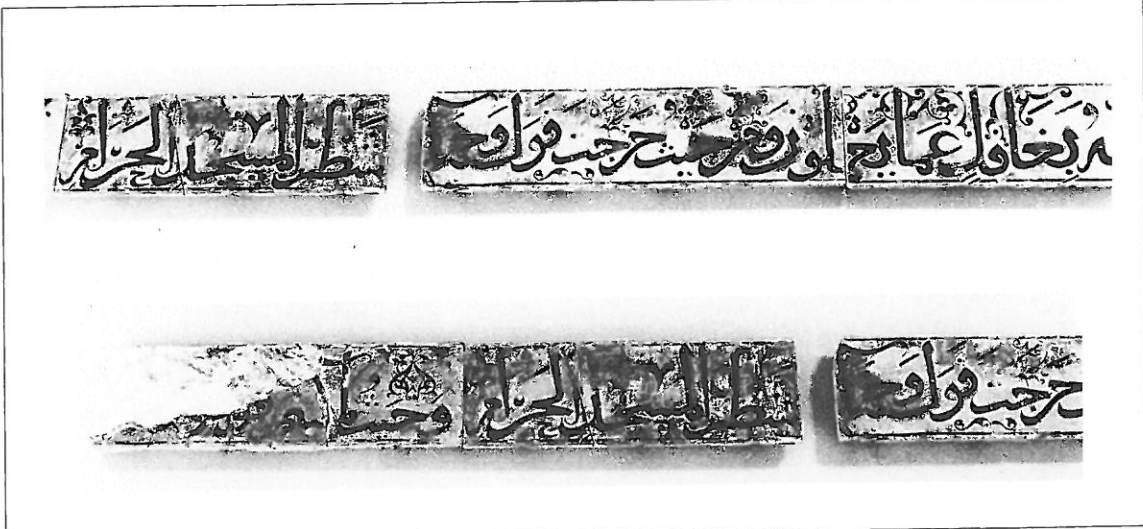

17. Iraqi Museum, Baghdad: Two inscription bands with Qur'an 2:148-149, previously at the mosque Al-Nūri in Mosul.

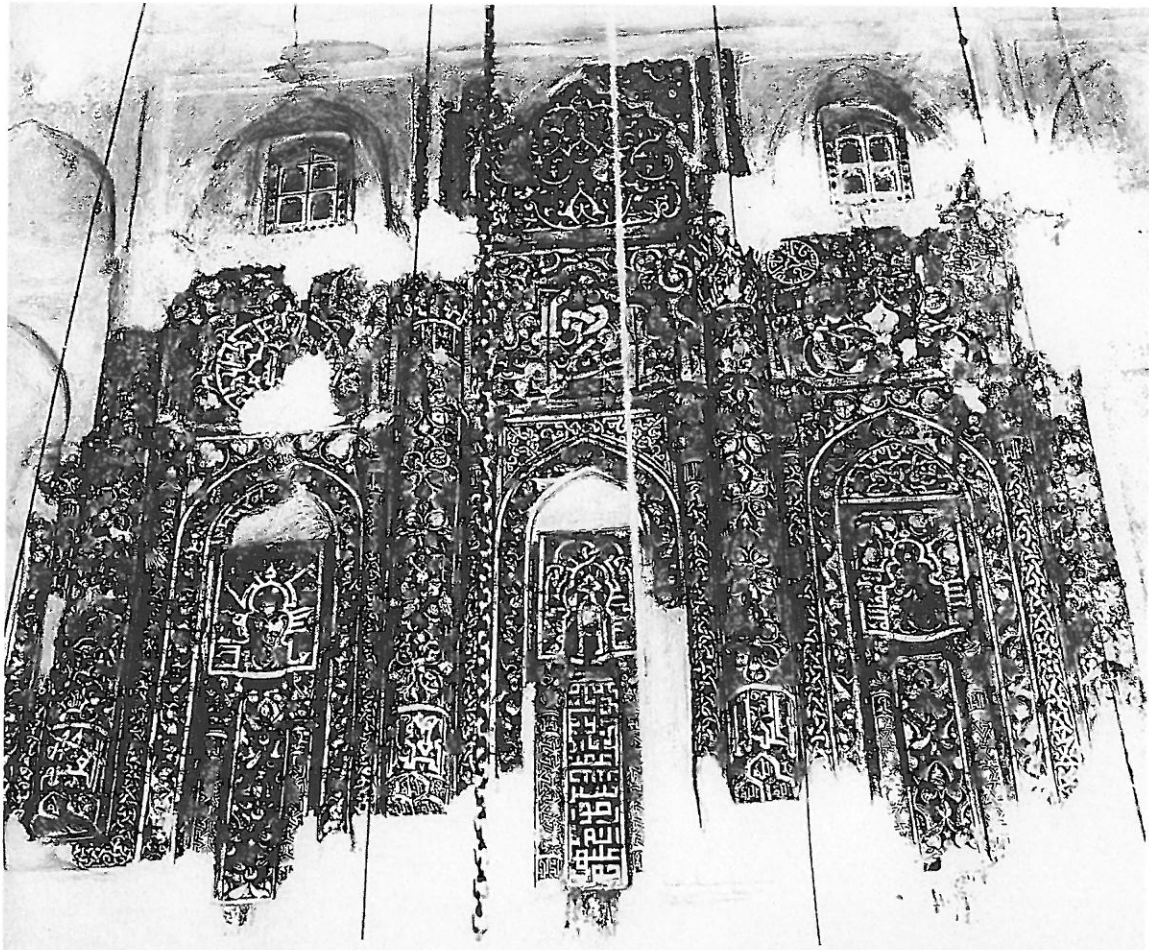

18. Mosul, Mosque Al-Nūri: Large stucco panel above the *mihrāb*, condition c. 1930, presently at the Iraqi Museum, Baghdad. (Courtesy of the General Institute for Antiquities, Baghdad).

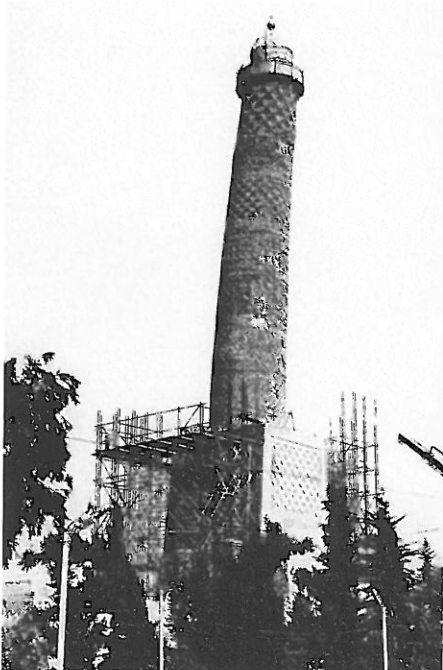

19. Mosul, Mosque Al-Nūri: Minaret, 1170-1172.



20. Mosul, Mosque Al-Nūri: Uppermost portion of minaret.

- Claude AUDEBERT 1 Verbes actifs et moyens dans le parler du Caire :  
une suite.
- Mohamed BAKHOUCHE 17 Le lexique technique chamelier  
dans le diwan *d'al-Aḥṭal*  
Contribution à la lexicographie arabe  
relative à la chamelle.
- Marianne BARRUCAND 37 Les chapiteaux de remploi de la mosquée al-Azhar  
et l'émergence d'un type de chapiteau médiéval  
en Égypte.
- Jean-Yves L'HOPITAL 77 Le vocabulaire amoureux  
dans les poèmes de 'Umar b. al-Fāriḍ.
- Julien LOISEAU 117 L'émir en sa maison  
Parcours politiques et patrimoine urbain au Caire,  
d'après les biographies du *Manhal al-Ṣāfi*.
- Sophie LONGEAUD 139 La mise en scène de l'espace architectural mamelouk :  
la *mandara* du palais al-Razzāz au Caire.



- Richard McGREGOR 177 *Being and Knowing*  
According to an 8th/14th Century  
Cairene Mystic.
- Nicolas MICHEL 197 Villages désertés, terres en friche et reconstruction  
rurale en Égypte au début de l'époque ottomane.
- Rudolph PETERS 253 Egypt and the Age of the Triumphant Prison:  
Legal Punishment in Nineteenth Century Egypt.
- Stéphane PRADINES, 287 La muraille ayyoubide du Caire:  
Benjamin MICHAUDEL les fouilles archéologiques de Bāb al-Barqīyya  
et Julie MONCHAMP et Bāb al-Maḥrūq.
- Yasser TABBAA 339 The Mosque of Nūr al-Dīn in Mosul, 1170-1172.
- حسام عبد الظاهر ١ أصحاب شرطة مصر فى العصر العباسى الأول  
[١٣٢-٢٣٢هـ / ٧٤٩-٨٤٧م]  
(رؤية جديدة فى ضوء الإحصاء التاريخى).
- محمد أبو العمائم ٢٣ أسوار مدينة القاهرة وخططها  
سور جوهر سنة ٣٥٨هـ/٩٦٩م.

# حَوَالِيَاتُ إِسْلَامِيَّةٍ

٣٦

مستخرج

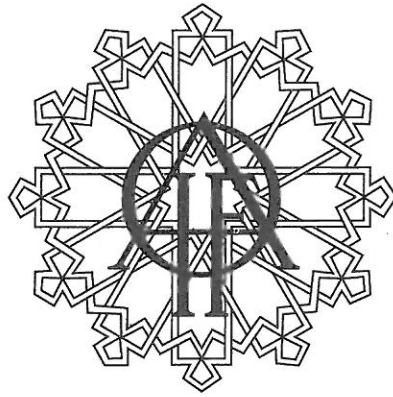

المعهد العالي الفرنسي للأبحاث الشرقيّة بالمتاهرة

حواليات إسلامية ٣٦ - ٢٠٠٢